

The home of the turntable

THE VINYL ENGINE®

For more turntable manuals and setup information
please visit www.vinylengine.com



S M E

SERIES II

PRECISION PICK-UP ARMS models 3009 and 3012

The best pick-up arm in the world



SME

The realism and clarity of a stereo record reflect the skill and technical perfection underlying its manufacture. Only when this is maintained in the reproducing equipment can justice be done to the art of the recording engineers. In playing a gramophone record the stylus must follow a path of extraordinary complexity and be highly compliant if the minute detail of the groove is to be traced without damage. Even the best cartridge cannot achieve this unless it is poised free from extraneous influences. The design of a carrying arm capable of realising the full potential of pick-up and record is highly specialised involving many problems. These have been successfully resolved in the S.M.E., an instrument of unrivalled quality presented with confidence that the user will endorse the claim 'The best pick-up arm in the world'.

DESIGN FEATURES

- Compensation is provided for the force which tries to move a pick-up arm towards the centre of a record. The arm is given an opposing bias, adjustable for various tracking pressures, which balances the stylus centrally in the groove so that it does not favour one wall.
- Precision ball races and knife-edge bearings reduce pivot friction to approximately .020 gramme measured at the stylus. Cartridges can be used at optimum stylus pressure without the excess weight otherwise required to overcome friction in the pivots.
- A carefully chosen offset minimises distortion due to tracking error.
- The tubular tone arm has a wood lining and the balance system is decoupled by a compliant joint. Resonances are placed where they can have no effect on the recorded range.
- The balance system permits accurate longitudinal and lateral balance of cartridges from 7-20 grammes weight and tracking pressures from $\frac{1}{4}$ to 5 grammes applied precisely without the need for a stylus pressure gauge.
- Versatile and quickly aligned for optimum tracking by sliding the base on its graduated bed plate using the protractor included with each arm. Full advantage can be taken of the best present and future cartridges, impracticable with arms of 'integrated' design.
- Lever operated raising and lowering control gives automatic slow descent. Fascinating to use—safeguards valuable records.
- Choice of tone arm length to suit space available. If the motor board is big enough the 3012 is better, tracking error is even smaller and for studio use 16" records can be played. Otherwise the 3009 can be used with every confidence and indeed is the one most frequently employed.

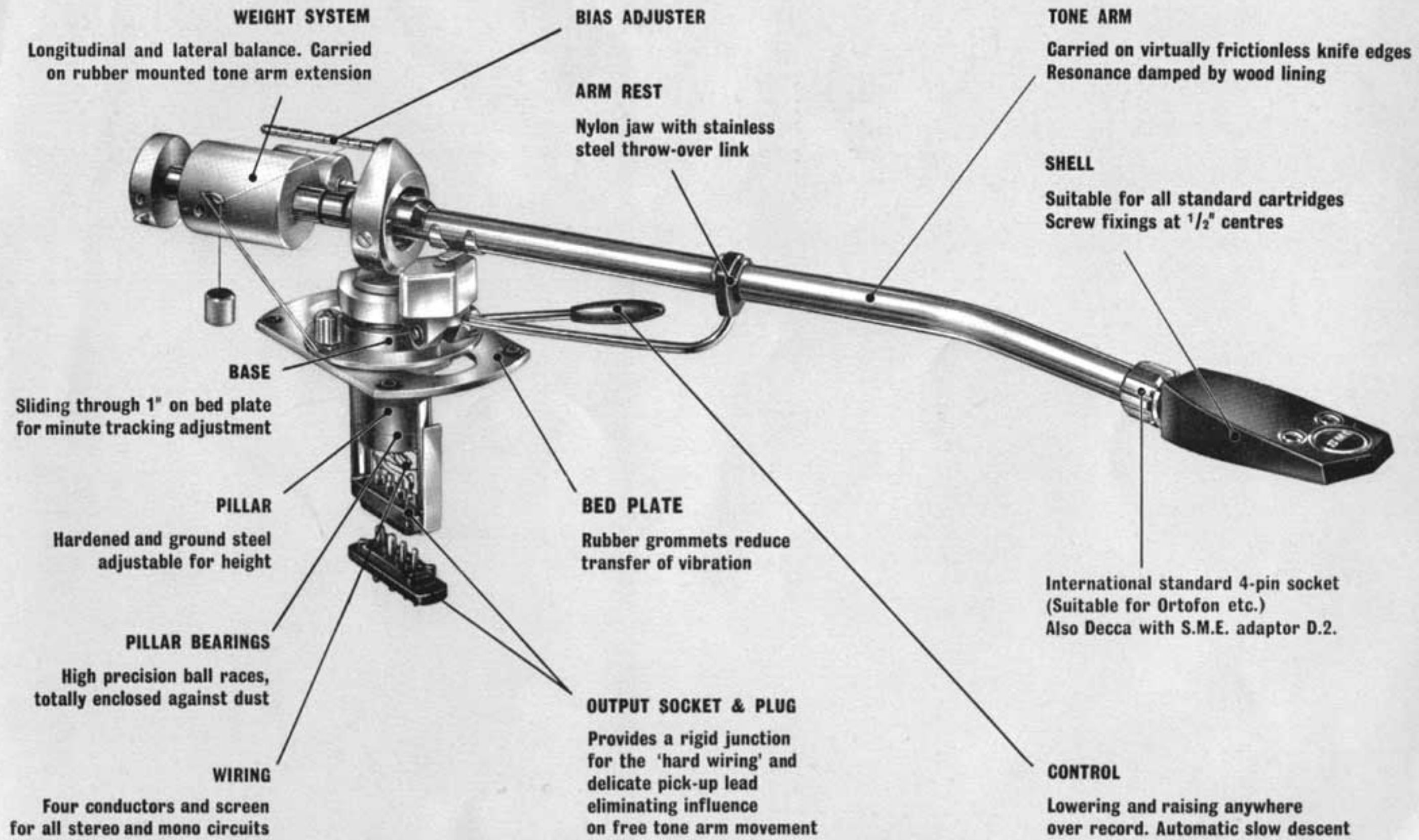

Motor board sizes for some popular turntables.

Depths are minimum for widths quoted but may be decreased a little if greater width is available.

		3009	3012
Connoisseur 2-speed	Width	17 $\frac{3}{4}$ "	21 $\frac{1}{2}$ "
	Depth front to back	16 $\frac{1}{2}$ "	16 $\frac{3}{4}$ "
Garrard 301	Width	17 $\frac{3}{4}$ "	21 $\frac{1}{2}$ "
	Depth front to back	17 $\frac{1}{2}$ "	17 $\frac{3}{4}$ "
Thorens TD 124	Width	17 $\frac{3}{4}$ "	21 $\frac{1}{2}$ "
	Depth front to back	16"	16"

We can supply a special board for mounting the model 3012 arm on the Thorens TD 124.

Shipping:—

		3009	3012
Weight Nett	1 lb. 5 ozs. 0.6 kgs.	1 lb. 7 ozs. 0.66 kgs.
	Gross	2 lbs. 2 ozs. 0.97 kgs.	2 lbs. 10 ozs. 1.20 kgs.
Carton size	11 $\frac{3}{4}$ " x 4 $\frac{1}{2}$ " x 7 $\frac{1}{2}$ "	16" x 4 $\frac{1}{2}$ " x 7 $\frac{1}{2}$ "

Each arm is packed complete with one shell, mounting template, alignment protractor, fixing screws, etc. and full instructions for use.

	3009	3012
Nominal length, pivot—stylus (dependent on cartridge) ...	9"	12"
'L' distance from pivot to turntable centre adjustable $\pm \frac{1}{2}$ " by sliding base	8.43"	11.58"
'H' adjustable to suit turntable		
Fully raised... ..	3 $\frac{1}{4}$ "	3 $\frac{1}{4}$ "
Fully lowered	2 $\frac{3}{8}$ "	2 $\frac{3}{8}$ "
'D' depth below top surface of motor board	2 $\frac{3}{4}$ "	2 $\frac{3}{4}$ "
'R' clearance to accommodate balance weights (radius struck from pivot with base in extreme rear position) ...	3 $\frac{1}{4}$ "	3 $\frac{3}{8}$ "

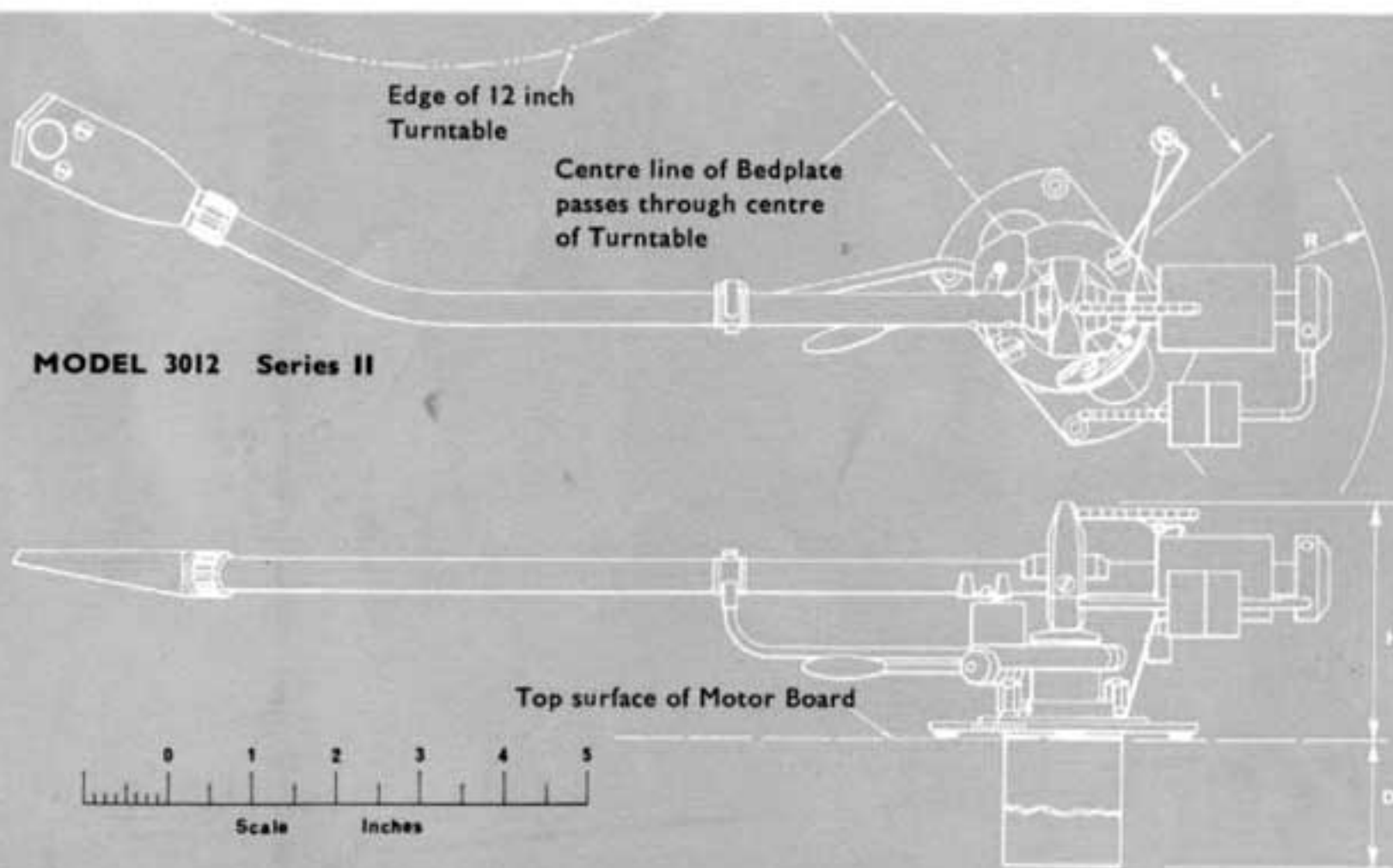

Manufactured in England by **S.M.E. LIMITED, STEYNING, SUSSEX**

Telephone: **STEYNING 2228**

STANDARD SHELL S.3

For all standard cartridges with fixings at $\frac{1}{4}$ " centres. Complete with mounting hardware and four colour-coded connecting tails with tags.



ULTRA LIGHT SHELL S.2

Aluminium with nearly 120 perforations. This is the lightest interchangeable shell available. Weighing only 6 grammes with mounting hardware it offers a valuable reduction in mass at the point of greatest effect. Developed for compliances of 20 and upwards it also offers useful weight saving with heavy lower compliance cartridges. Requires appropriate companion balance weight.



COMPANION BALANCE WEIGHTS W/9 W/12

For use on Series II arms with ultra light shell S.2, or adaptor D.3, replacing standard balance weight supplied. W/9 for model 3009 Series II W/12 for model 3012 Series II

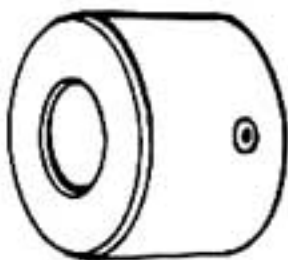

ADAPTOR D.3

For mounting Decca ffs pattern heads. One adaptor serves any number of heads. Requires appropriate companion balance weight.

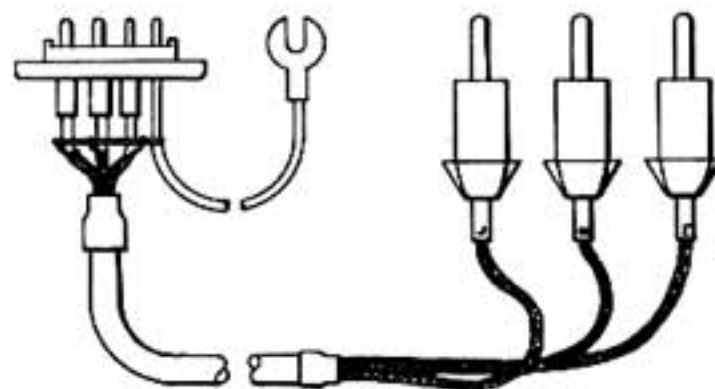
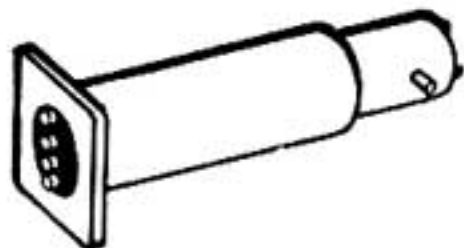

AMPLIFIER CONNECTING LEAD

Three-wire system recommended for all cartridges. Terminates in phono plugs at one end and S.M.E. plug at the other. Motor earth connection provided.

L.2. length 2'
L.4. " 4'
L.6. " 6'

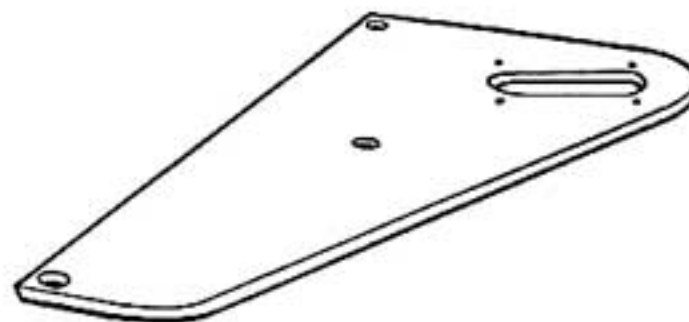

PICK-UP MOUNTING BOARD

TD124 3012

For Model 3012 on Thorens TD124 transcription turntable. Polished black Perspex with all holes cut. Complete with mounting screws and lock nuts.

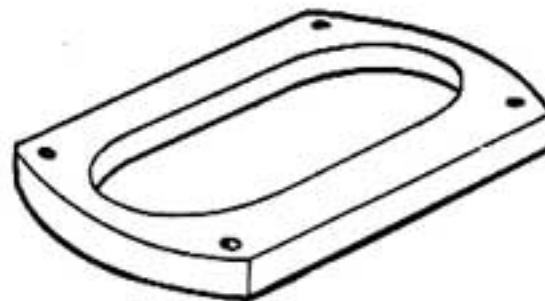

PLINTH P.1.

For raising base of pick-up when used with deep turntable units. Polished black Perspex, complete with plated woodscrews.

SME

SME Precision Pick-up Arm complete with 4' connecting lead, mounting template, alignment protractor, fixing screws and instructions for use:—

	<i>Basic Price</i>	<i>P. Tax (U.K. only)</i>	<i>Total</i>
Model 3009 with ultra-light Shell S.2 ...	£22 17s. 6d.	£5 1s. 8d.	£27 19s. 2d.
Model 3009 without Shell ...	£21 1s. 6d.	£4 13s. 8d.	£25 15s. 2d.
Model 3012 with ultra-light Shell S.2 ...	£24 7s. 6d.	£5 8s. 4d.	£29 15s. 10d.
Model 3012 without Shell ...	£22 11s. 6d.	£5 0s. 4d.	£27 11s. 10d.

Accessories

S.2 Ultra-light Shell, boxed with mounting hardware and finger lift ...	£1 16s. 0d.	8s. 0d.	£2 4s. 0d.
D.3 Adaptor for Decca ffs pattern heads ...	£2 0s. 0d.	8s. 10d.	£2 8s. 10d.
P.1 Spacer to adjust height difference when arm is used with a deep turntable ...	15s. 0d.	3s. 4d.	18s. 4d.
TD124/3009 Mounting Board to fit Model 3009 on Thorens TD124 ...	£2 17s. 6d.	12s. 9d.	£3 10s. 3d.
TD124/3012 Mounting Board to fit Model 3012 on Thorens TD124 ...	£3 10s. 0d.	15s. 6d.	£4 5s. 6d.